

Paramount

Item number: EF-125-13
Model number: BLT-999A-7

ELECTRIC FIREPLACE INSERT

INSTRUCTIONS FOR USE



READ & SAVE THESE INSTRUCTIONS

Carefully read and review before assembling, installing, operating or maintaining this product. Observe all safety instructions and information.

FAILURE TO FOLLOW WARNINGS & OPERATIONAL INSTRUCTIONS CONTAINED IN THIS MANUAL CAN RESULT IN PROPERTY DAMAGE OR PERSONAL INJURY.

****IMPORTANT NOTICE****

Please contact

customer care@jrhome.com

For customer service & warranty issues



Read these instructions completely before beginning installation. Failure to follow them could cause a heater malfunction resulting in serious injury and/or property damage.

 **WARNING:** All electric heaters have hot and arcing or sparking parts inside. Do not use it in areas where gasoline, paint or flammable liquids are present.

 **WARNING:** This electric fireplace is tested and listed for use only with the optional accessories listed in these instructions. Use of optional accessories not specifically tested for this electric fireplace could void the heater warranty and/or result in a safety hazard.

This electric fireplace meets the construction and safety standards of H.U.D. for application in manufactured homes when installed according to these instructions.

IMPORTANT SAFETY INSTRUCTIONS

- 1/ Prior to plugging your heater into an electrical outlet, verify that the house circuit breakers for the outlet are on.
- 2/ The heater may emit a slight, harmless odor when first used. This odor is normal and it is caused by the initial heating of internal heater elements and will not occur again.
- 3/ If your heater does not emit heat, consult the operation section of this manual for further information.
- 4/ Use with a CSA or UL certified surge protector.



SA1965

CAUTION:
RISK OF ELECTRIC SHOCK
DO NOT OPEN
NO USER-SERVICEABLE PARTS INSIDE
HIGH TEMPERATURE



SA1965

KEEP ELECTRICAL CORDS, DRAPERY AND OTHER FURNISHINGS AT LEAST 3 FEET (0.9m) FROM THE FRONT AND SIDES OF THE HEATER.

 **CAUTION:** High temperature, risk of fire. Keep electrical cords, drapery, furnishings, and other combustibles at least 3 feet (0.9m) from the front of the heater and away from the side and rear.

 **WARNING:** Servicing should be done only while the heater is disconnected from the power supply circuit.

IMPORTANT SAFETY INSTRUCTIONS

IMPORTANT INSTRUCTIONS

When using this electric fireplace, basic precautions should always be followed to reduce the risk of fire, electric shock and injury to persons, including the following:

- 1/ Read all instructions before using this electric fireplace.
- 2/ This heater is hot when in use. To avoid burns, do not let bare skin touch hot surfaces. Keep combustible materials, such as furniture, pillows, bedding, papers, clothes and curtains at least 3 feet (0.9m) from front of heater and keep them away from sides and rear
- 3/ Extreme caution is necessary when any heater is used by or near children and whenever the heater is left operating and unattended.
- 4/ Always unplug electric fireplace when not in use.
- 5/ Do not operate this electric fireplace with a damaged cord or plug or after heater malfunctions, has been dropped or damaged in any way. Return heater to authorized service facility for examination, electrical or mechanical adjustment or repair.
- 6/ Do not use this electric fireplace outdoors.
- 7/ This electric fireplace is not intended for use in bathrooms, laundry areas and similar indoor locations. Never locate electric fireplace where it may fall into a bathtub or other water container.
- 8/ Do not run cord under carpeting. Do not cover cord with throw rugs, runners or the like. Arrange cord away from traffic area and where it will not be tripped over.
- 9/ To disconnect electric fireplace, turn controls to "OFF" before removing plug from outlet.
- 10/ Connect to properly grounded outlets only.

IMPORTANT SAFETY INSTRUCTIONS

- 11/ Do not insert or allow foreign objects to enter any ventilation or exhaust opening as this may cause an electric shock or fire or damage the heater.
- 12/ To prevent possible fire, do not block air intakes in any manner. Do not use on soft surfaces, like a bed, where openings may become blocked.
- 13/ The electric fireplace has hot and arcing or sparking parts inside. Do not use it in areas where gasoline, paint or flammable liquids are used or stored.
- 14/ Use this electric fireplace only as described in this manual. Any other use not recommended by the manufacturer may cause fire, electric shock or injury to persons.
- 15/ Always use properly grounded fused and polarized outlets.
- 16/ Always use ground fault protection where required by electrical codes.
- 17/ Always disconnect power before performing any cleaning, maintenance or relocation of heater.
- 18/ To prevent a possible fire, do not burn wood or other materials in this electric fireplace.
- 19/ To prevent electric shock or fire, always hire a certified electrician should new circuits or outlets be required.
- 20/ When transporting or storing this electric fireplace, keep in a dry place free from excessive vibration and store as to avoid damage.
- 21/ Always plug heaters directly into a wall outlet/receptacle. Never use with an extension cord or relocatable power tap (outlet/power strip)
- 22/ This electric fireplace is not designed for "zero" tolerance wall and/or cabinet/millwork installations. Accessibility for servicing and maintenance must be possible without disturbing building structure and/or cabinet/millwork finishes. Allow 6cm/2.4" clearance from the top of the insert to any building material surface and 3cm/1.18" clearance from the sides to any building material surface.

SAVE THESE INSTRUCTIONS!

LISTING APPROVALS

This heater has been tested in accordance with the CSA Standards for fixed and location-dedicated electric room heaters in the United States and Canada. If you need assistance during installation, please contact your local dealer.

Fireplace Insert Specifications

Dimensions W x D x H:	24.8" x 18.5" x 8.7"
Net Weight	31.5 lbs / 14.3 kg
Gross Weight	36.3 lbs / 16.5 kg
Voltage	110 – 120 V
Frequency	60 Hz
Watts	1400 W
Heater Rating	4774 BTUs

Note: This heater must be electrically wired and grounded in accordance with local codes or, in the absence of local codes, with National Electric Code ANSI/NFPA 70-latest edition or the Canadian Electric Code, CSA C22.1 as appropriate.

LOCATING FIREPLACE



WARNING: Due to high temperatures, this electric fireplace should be located out of traffic. Keep combustible materials such as furniture, pillows, bedding, papers, clothes and curtains at least 3 feet (0.9m) from the front of the heater.



WARNING: Never locate this electric fireplace where it may fall into a bathtub or other water container.



CAUTION: Do not expose the electric fireplace to the elements (such as rain, etc.)



CAUTION: Wear gloves and safety glasses for protection during installation and maintenance.



WARNING: To prevent contact with sagging or loose insulation, the electric fireplace must not be installed against vapor barrier or exposed insulation. Localized overheating could occur and a fire could result.

UNPACKING AND TESTING FIREPLACE

Carefully remove the unit from the box. Prior to installing the unit, test to make sure the unit operates properly. To do this, plug the unit's power supply cord into a conveniently located 120-Volt grounded outlet.

GROUNDING INSTRUCTIONS

This insert is for use on 120 Volts.

The cord has a plug as shown in (A) of Figure 2 given below.

Always plug heaters directly into a wall outlet/receptacle. Never use with an extension cord or relocatable power tap (outlet/power strip)

To disconnect heater, turn controls to off, then remove the plug from outlet.

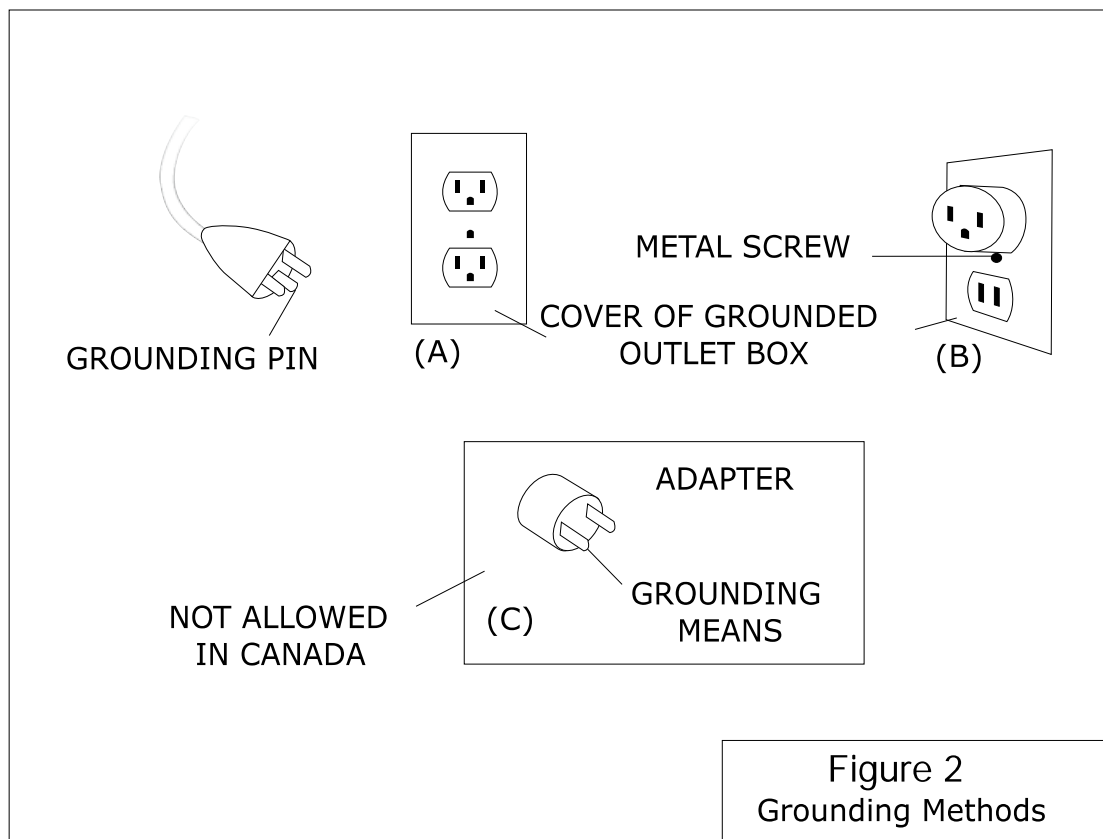

INSTALLATION



WARNING: RISK OF FIRE! The power cord must not be pinched or against a sharp edge. Secure cord to avoid tripping or snagging to reduce risk of fire, electric shock or personal injury. Do not run cord under carpeting. Do not cover cord with throw rugs, runner or the like. Arrange cord away from traffic area and where it will not be tripped over.



WARNING: RISK OF FIRE! To prevent a possible fire, do not block air intake or exhaust in any manner. Do not use on soft surfaces where openings may become blocked.



WARNING: RISK OF FIRE! Do not blow or place insulation against the fireplace.



WARNING: This electric fireplace is tested and listed for use only with the approved optional accessories. Use of optional accessories not specifically tested for this electric fireplace could void the heater warranty and/or result in a safety hazard.



WARNING: If the information in these instructions is not followed exactly, a fire or explosion may result causing property damage, personal injury or death. Do not store or use gasoline or other flammable vapors in the vicinity of this or any other heater.

FINISHING CHECKLIST

- > Power supply service must be completed prior to finishing to avoid reconstruction.
- > Heater vents and air openings cannot be covered in any circumstances.

OPERATING INSTRUCTIONS

All of the fireplace insert control functions can be accessed in 2 ways:

1. Using a remote control
2. Using the manual controls located behind the access panel on the bottom left side of the fireplace insert.

This fireplace insert features conveniently separate controls for the flame effect and for heat control.

This feature allows you to operate the unit in 2 different ways:

- As a full featured fireplace insert with both the flame effect and heater on.
- As a visual effect with the flame effect only.

Refer to the pictures for location of the buttons on both the remote control unit and the fireplace insert itself.

OPERATING INSTRUCTIONS

The manual controls are located on the left side of the fireplace.

You have the following controls:

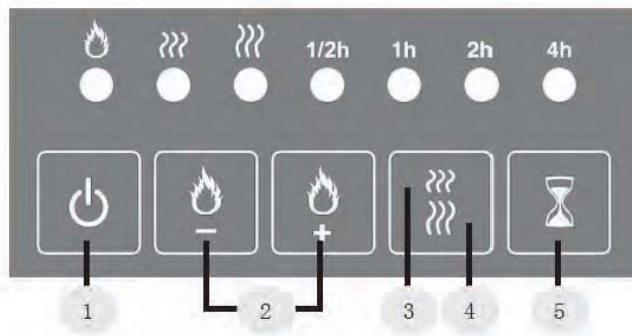

1. Power ON/OFF: Power to the unit
2. Flame brightness controls: Allows you to adjust the flame to suit your mood. Press to increase flame brightness and to decrease flame brightness. You must press the button several times to see the full flame effect
3. Low heat 750 watts
4. High heat 1400 watts

Please note: The heater touchpad control must be touched 2 times to achieve high heat.

5. Heater Timer: Allows you to leave your heater on with an automatic timer for shut off. You can set your heater to be on for 1/2 hour increments starting at a 1/2 hour up to a maximum of 7-1/2 hours – press once for each 1/2 hour increment. After you reach 7-1/2 hours the next press will shut off the feature.

REMOTE CONTROLS

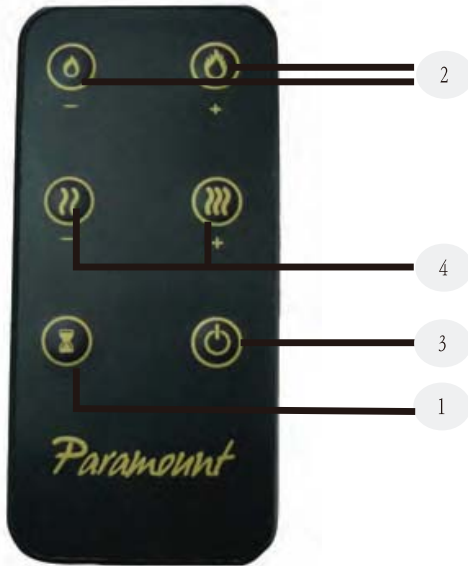

1. Heater Timer: Allows you to leave your heater on with an automatic timer for shut off. You can set your heater to be on for 1/2 hour increments starting at a 1/2 hour up to a maximum of 7-1/2 hours – press once for each 1/2 hour increment. After you reach 7-1/2 hours the next press will shut off the feature.
2. Flame brightness controls: Allows you to adjust the flame to suit your mood. Press to increase flame brightness and to decrease flame brightness. You must press the button five times to see the full flame effect
3. Power ON/OFF: Power to the unit
4. Heater Control: Press once for low heat, and twice for high heat.

REPLACING THE LIGHT BULBS

This fireplace insert uses 3 clear 120 Volt, 4 Watt, E-12 socket base light bulbs (small base, chandelier candle type bulbs). The lights are located at the bottom of the unit. For convenience, if one of the light bulbs burns out, it may be easier to replace both of the light bulbs at the same time.

WARNING: Do not exceed 4 Watts per bulb. Use of higher rated bulbs may result in a fire, causing property damage, personal injury or loss of life.

1. Turn off the power to the unit.
2. Let the fireplace insert cool if it has been operating.
3. Gently pull the mantel away from the wall. Unplug the firebox. Take the firebox by the side handles and slide it out of the mantel. Be careful not to scratch the mantel base.
4. Once you have the fireplace insert free of the mantel, lie the unit on its back with the bottom facing you. You will see 1 small plate with gold printing indicating the bulbs are behind these plates.
5. Remove the 6 screws with an appropriate screwdriver. Once you have removed the 6 screws slightly lift the plate until you can pull back and release the tabs. Once you have removed the plate you can see and access the 2 - 4 Watt bulbs.
6. Remove each light bulb by unscrewing them out of the bases, turning them counterclockwise. You can use one hand to hold the light socket in place, if required.
7. Install the new light bulbs by turning each light bulb into the base clockwise. You can use one hand to hold the light socket in place, if required.
8. Replace each cover plate by inserting the tabs and lowering the plate.
9. Replace the 6 screws in each plate that were removed in Step 5, by using an appropriate screwdriver.
10. Stand the fireplace insert up on its bottom.
11. Use the side handles to position the fireplace insert back on to the mantel hearth.

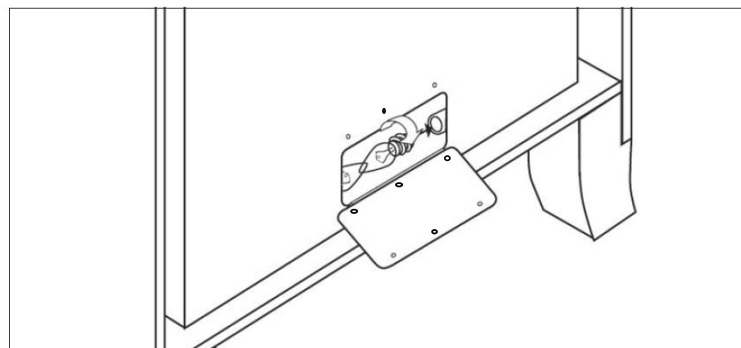

TROUBLESHOOTING



WARNING: Turn off the fireplace completely and let cool before servicing.

PROBLEM	POSSIBLE CAUSE	CORRECTIVE ACTION
1. No power, no indicator lights	Insert was not plugged in	Make sure that power cord is plugged into 120 V outlet
2. No power, no indicator lights	No power at outlet	Check circuit breaker or fuse
3. Power indicator lights come on, logs will not glow and no flame effect	Broken or burned out light bulbs	Follow instructions for replacing light bulbs
4. Logs glow, but no flame	Flame spinner disconnected	Call customer service for instructions
5. Flame and logs glow, but no heat	Heater switch is off	Push heater button. Indicator light will come on
6. Heater and/or flame turn off while operating	Timer function may have been on	Push On/Off button to reset

IMPORTANT

For questions, concerns or problems with our product please email our customer service department:

customercare@jrhome.com

DATED PROOF OF PURCHASE REQUIRED FOR WARRANTY SERVICE

Si vous éprouvez des difficultés, ou si vous avez des questions ou des préoccupations, prière de faire parvenir un courriel à notre Service à la clientèle

customercare@jrhome.com

UNE PREUVE D'ACHAT DATÉE EST REQUISE POUR SE PRÉVALOIR DE LA GARANTIE.

WARRANTY

This product is inspected, tested and carefully packaged to minimize the chance of damage during shipment. If a part (excluding light bulbs, glass and fuses*) within one year from the date of purchase proves to be defective in material or fabrication under normal use, the part will be repaired or replaced. The Company's obligation under the warranty is to replace or repair defective parts at our discretion. Any expenses or damage resulting from the installation, removal or transportation of the product will be the responsibility of the owner and are not covered by this warranty. The owner assumes all other risks arising from the use or misuse of the product. The warranty will be void if the product damage or failure is deemed by the Company to be caused by accident, alteration, misuse, abuse, incorrect installation or removal, or connection to an incorrect power source by the owner. The Company neither assumes, nor authorizes any person or entity to assume for it any obligation or liability associated with its products. Light bulbs and fuses are not covered under this warranty. If you have any questions regarding the warranty or service, please contact us at **customercare@jrhome.com**

Customer Service:

JR Home Products

Unit 306 - 19100 Airport Way, Pitt Meadows, BC V3Y 0E2

Toll Free: 1-800-561-5550

E-mail: **customercare@jrhome.com**

AVERTISSEMENT

Ce produit a été soigneusement inspecté, testé et emballé afin de minimiser les risques de dommages durant le transport. Si l'une des pièces (à l'exception des ampoules électriques verre et des fusibles*) s'avère défectueuse au niveau de sa fabrication ou de ses matériaux dans l'année qui suit la date de l'achat, suite à une utilisation normale, la pièce sera réparée ou remplacée. La Compagnie est tenue de réparer ou remplacer les pièces défectueuses, à sa discrétion, en vertu de la garantie. Tout frais ou dommage résultant de l'installation, du démantèlement ou du transport du produit demeure la responsabilité du client et n'est pas couvert par cette garantie. Le client assume tout autre risque résultant de l'utilisation, correcte ou fautive, du produit. La garantie devient nulle si la Compagnie détermine que le dommage ou le mauvais fonctionnement est causé par un accident, une modification, une mauvaise utilisation, un abus, une mauvaise installation ou un mauvais démantèlement ou un branchement à une source électrique inadéquate de la part du client. La Compagnie n'est pas responsable et n'autorise quiconque, personne ou entité légale, à accepter de responsabilité ou obligation en son nom, en rapport avec ses produits. * Les ampoules électriques et les fusibles ne sont pas couverts par cette garantie. Pour toute question en rapport avec la garantie ou le service, envoyez-nous un courriel à: **customercare@jrhome.com**.

Service à la clientèle :

JR Home Products

Unit 306 - 19100 Airport Way, Pitt Meadows BC V3Y 0E2

Toll Free: 1-800-561-5550

E-mail: **customercare@jrhome.com**

You MUST register your product to receive warranty service.

Registration can be completed online at www.jrhome.com or by mailing this form.

Vous DEVEZ enregistrer votre produit pour vous prévaloir de la garantie.

L'enregistrement sera complet une fois que vous aurez posté ce formulaire ou s'inscrire en ligne à :

Warranty Registration Information Form / Formulaire d'enregistrement de la garantie

Name / Nom: _____

Street / Address: _____

City / Ville: _____

Province / Province: _____

Postal Code / Code postal: _____

Daytime Phone # / No téléphone jour: _____

Evening Phone # / No téléphone soir: _____

E-Mail Address / Courriel: _____

Product/Produit: _____

Place of Purchase / Lieu de l'achat: _____

Date of Purchase / Date de l'achat: _____

Model # / No de modèle: _____

Serial # / Numéro de série: _____

You MUST register your product to receive warranty service.

For warranty service, contact J&R Home Products at the address, phone numbers listed below within 30 days of purchase. Be sure to have your sales receipt and original date of purchase. All warranty service will be coordinated by J&R Home Products service center.

Vous DEVEZ enregistrer votre produit pour vous prévaloir de la garantie.

Afin de faire valoir la garantie, communiquez avec J&R Home Products à l'adresse et aux numéros indiqués ci-dessous dans les 30 jours suivant la date d'achat. Ayez en main votre reçu et la date d'achat. Toutes les demandes liées aux garanties seront traitées par le centre de service de J&R Home Products.

Please mail to / Veuillez poster le tout à : Parts & Service Department, J&R Home Products Ltd. Unit 306 - 19100 Airport Way, Pitt Meadows, BC V3Y 0E2